

RESTRICTED.

The information contained in this Report is not to be communicated, either directly or indirectly, to the press or to any person not authorised to receive it.

# JAPANESE AMMUNITION

## C.I.AMM. TECHNICAL REPORT

No. 32

---

H.E., A.T.,  
(HOLLOW CHARGE) GRENADE  
FOR 30-MM. RIFLED DISCHARGER CUP  
AND ITS ADAPTATION AS  
1/3 Kg., H.E., A/C.,  
(HOLLOW CHARGE) BOMB

RESTRICTED.

JAPANESE AMMUNITION.

C.I.AMM. TECHNICAL REPORTS.

REPORT NO. 32.

FEBRUARY 1945.

H.E., A.T. (HOLLOW CHARGE) GRENADE  
FOR  
30-MM. RIFLED DISCHARGER CUP  
AND  
ITS ADAPTATION  
AS  
1/3 Kg., H.E., A/C. (HOLLOW CHARGE) BOMB.

G E N E R A L.

A number of hollow charge A.T. rifle grenades were received at this Inspectorate, late in 1944. It is believed, a small number were used by the Japanese in the Burma campaign.

Before describing this grenade and its adaptation as a 1/3 Kg. H.E., Aircraft Bomb, it will be useful to make some general remarks.

2. From a user aspect the grenade may be regarded as the Japanese equivalent to our Grenade, H.E., A.T., No.68 or the American M.9 A.1 A.T. Grenade. The method of projection is, however, different. A rifled discharger cup being fitted to the rifle, which imparts a rotary motion to the grenade and gives the necessary stability in flight and head on impact.

3. The Japanese grenade is an obvious copy of the German hollow charge rifle grenade (Gewehr Panzergranate). Although the tail of the Japanese grenade is identical with that of the German (30-mm.) and fits the 30-mm. rifled discharger cup, the body is not quite the same. It is larger than the small German hollow charge grenade, but not quite so large as the large German grenade (Gross Gewehr Panzergranate).

According to reports, a 6.5-mm. propellant cartridge with a wooden bullet is used for projection of the grenade, but none has been received at Kirkee for examination. There is of course no reason why the discharger cup could not be fitted to Japanese rifles of 7.7 and 7.92-mm. calibres.

According to old reports (1943), penetration when fired statically against a mild steel plate, is 3 7/8-ins., making a hole of approximately 1/2-in. in diameter at the point of entry.

4. This grenade has been adapted by the Japanese as an aircraft bomb by the fitting of vanes and a modified fuze. One of these was recovered unexploded, late last year after a small Japanese bombing attack on the East coast of India. The bomb was forwarded here for examination. A full description of this type of bomb is, therefore, also included in this Report. It is known that these bombs are dropped in clusters from a container. One type of container is designed to hold 30 bombs and the other to hold 76. Initial reports stated that they were intended for A.A. use, but it seems unlikely that this can be

their primary role.

## H.E., A.T. (HOLLOW CHARGE) GRENADE.

### DESCRIPTION.

5. The make up and general arrangement of the grenade can be seen from the drawings and photographs:-

- Plate A:- Drawing. showing internal details and assembly sequence of fuze components.
- Plate B:- Drawing showing external appearance, markings on the grenade and the general design of the 30-mm. rifled discharger cup attachment.
- Plate C:- Photograph of the grenade showing its general external appearance and the assembly sequence of all components.
- Plate F:- Comparative photograph of the A.T. grenade and a 1/3 Kg. H.E. aircraft bomb.

### Body.

6. The steel body (3) of the grenade is painted black or rust-proofed with a black finish. It is cylindrical in shape with a parabolic steel ballistic cap (1) at the head. This also serves as an impact cap to give the necessary stand-off distance to ensure maximum effect from the hollow charge. The tail extension (8) is of smaller diameter than the body and is screwed on at the base of the grenade body. Note the steel liner (2) with a 20° cone, which forms the necessary cavity in the filling to give a hollow charge effect. This steel liner (2) is closed at the narrow end by a small mild steel cup soldered on. The steel liner (2) and ballistic cap (1) are held in position by the mouth of the grenade body (3) being crimped and turned over as shown in the drawing, Plate A.

### Filling.

7. The body of the grenade has a main filling of R.D.X. and T.N.T. while towards the tail end it is filled with R.D.X. and wax; - see Plate A. The more sensitive filling at the base is presumably intended to boost up the impulse from the exploder and to give the maximum rate of detonation to the main filling. Full details of the filling are given in the chemical analysis below.

### Tail Extension.

8. The tail extension (8), which is secured to the body by right handed screw threads, is made of aluminium or light alloy such as duralumin, anodised to prevent surface corrosion. It is recessed at both ends forming two compartments with a diaphragm in between. This is perforated and in it is fitted a small detonator (7) held in place by a perforated screwed plug (6). In the rear compartment is the fuze mechanism and in the front is the exploder or booster pellet (4).

Exploder pellet.

9. This is a self contained unit consisting of a light aluminium cup holding a main filling of 95 grs. of R.D.X. and wax. The filling is recessed to take a flanged aluminium alloy cup or tube containing P.E.T.N. and wax at the bottom, over which is an aluminium alloy inverted cup containing lead azide. This cup is perforated to allow the flash from the cap to pass unobstructed to the lead azide. The exploder container is surrounded by a rolled paper tube (5) which ensures snug fitting of the exploder in the tail of the grenade. Full details of this exploder are given in Plate A, while the filling is described under chemical analysis below.

Fuze.

10. The mechanism of the fuze is fully detailed in Plate A, and this, together with the assembly sequence of components in Plate C, will make its construction clear. It consists of an inertia pellet (16) carrying a needle. This inertia pellet with needle is held away from the detonator (7) by an arming (clock type) spring (9). This spring (9) is held inside an arming sleeve (10), which is supported by a strong set back spring (11) held in compression between an external flange on the arming sleeve (10) and a steel collar (14) at the base of the inertia pellet (16). The arming sleeve (10) is prevented from rising under the pressure of the set back spring (11) by a ferrule (13), which is secured to the head of the inertia pellet (16) by a retaining washer (12). This ferrule (13) has four prongs which engage in a circular groove inside the arming sleeve (10), preventing upward movement of the latter. A second internal groove is formed near the top of the arming sleeve (10) to engage the prongs of the ferrule (13) when the fuze is armed.

Safety devices.

11. The grenade is safe during handling and transport, because the coiled arming spring (9) is bearing against the diaphragm in the tail extension (8) thus preventing the inertia pellet (16) from moving forward. This arming spring (9) is prevented from uncoiling by the strong set back spring (11) holding the arming sleeve (10) forward until the fuze is armed on firing.

Action.

12. On acceleration the arming sleeve (10) sets back compressing the set back spring (11) and is prevented from moving forward on deceleration by the prongs of the ferrule (13) entering the internal groove near its head. The arming spring (9) is then free to uncoil outwards into the recess in the tail extension. This uncoiling of the spring is probably assisted by the rotation of the grenade. The inertia pellet (16) is therefore now free to move forward except for the light creep spring (15), which prevents creep during flight. On graze or impact, the inertia pellet carrying the needle moves forward through the arming spring (9) to pierce the detonator and cause the grenade to function.

1/3 Kg. H.E., AIRCRAFT BOMB (HOLLOW CHARGE).

13. The construction of this bomb will be seen clearly from the drawings and photographs:-

- Plate D:- Drawing of the bomb showing internal details and dimensions.  
Plate E:- Photograph showing its external appearance and the sequence of assembly of the components.  
Plate F:- Comparative photograph of the bomb and the A.T. rifle grenade.

This plate shows two types of bombs:-

- (i) One with a light alloy vanes secured to the tail extension by screws.
- (ii) The other with varnished tinned plate vanes secured by pressing into three grooves in the cone portion of the tail extension.

Body.

14. The body conforms generally to that of the grenade described above, both in size and construction, except that in the sample examined the steel liner (2):-

- (i) forms a much wider cone (50°) thus giving more space for filling.
- (ii) is of much thinner metal and the method of attachment of it and the steel ballistic (or impact) cap (1) to the body has been somewhat simplified.
- (iii) is formed from one pressing of mild steel.

Filling.

15. The filling is the same as described above except that the quantity is somewhat greater. See chemical analysis below.

Exploder.

16. The exploder unit is identical with that used in the grenade. Full details of the explosives are given under chemical analysis below.

Tail extension.

17. The tail extension is made of anodised aluminium or a light alloy, such as duralumin, similar to the tail extension of the grenade described above, but differs somewhat from it in construction. While the portion above the diaphragm to house the exploder (14) is identical with that of the grenade, the portion below, is in two parts screwed together with a R.H.T. This lower portion forms a tail cone adapter (11) to take externally the vane assembly (13), and internally to house the inertia pellet with needle (10) and spring (9) - See Plate D for details. The tail cone adapter (11) has two tommy holes near the head for assembly purposes. There are also three other holes:-

- (a) A screw threaded hole (R.H.) to take a small anti-rotation screw to prevent turning of the inertia pellet (10) which might cause the arming spindle (12) to jam. It also ensures that the inertia pellet (10) is correctly positioned for the safety wire to pass through it and the tail cone adaptor (11).
- (b) A hole for the safety wire which passes right through the tail cone adapter (11) and inertia pellet (10).
- (c) A screw threaded hole (R.H.T.) into which screws the arming spindle (12).

#### Fuze.

18. This consists of a simple inertia pellet (10) mechanism with needle and spring (9), see details in Plate D.

#### Safety devices.

- 19. (a) A safety wire which passes right through the tail (11) of the bomb and the inertia pellet (10) thus preventing the latter from moving during handling and transport. It is probable that all bombs in a container will have the same wire passing through each tail. On release of the bombs the wire is withdrawn through the tail when the bomb is dropped.
- (b) An air operated arming spindle (12) which during handling and transport is screwed into the tail (11) and through a hole in the shank of the inertia pellet (10).
- (c) A spiral spring (9) which holds up the inertia pellet (10) and the detonator (7) during flight and ensures more positive functioning on impact. This is not really a safety device, except in regard to a very light check of the bomb during flight.

#### Action.

20. The bombs are released from the container in a cluster; the safety wire being drawn through the tail as each bomb falls. As soon as they leave the container, pressure acting on the cups of the arming spindle (12) causes them to rotate thus unscrewing the spindle (12) which falls clear, leaving the inertia pellet (10) and striker held off the detonator (7) only by the spring (9). On impact the inertia pellet (10) goes forward to fire the detonator (7).

#### METALLURGICAL ANALYSIS.

21. No detailed metallurgical analysis has yet been carried out. The body of both grenade and bomb appears to be made of mild steel painted or otherwise rust-proofed externally with a black finish and lacquered internally.

The tail extension is of a light aluminium alloy (appears to be duralumin), while the vanes are of two kinds, light aluminium alloy and lacquered tinned plate sheet. The latter was found on bombs of more recent manufacture.

CHEMICAL ANALYSIS.

(By the Chief Inspector of Military Explosives, Kirkee).

	<u>H.C. Grenade.</u>	<u>H.C. A/C. Bomb</u>
Filling in the body.	3.6-ozs. of T.N.T./R.D.X. (50/50).	4-ozs. of T.N.T./R.D.X. (51/49).
Booster filling in the tail extension.	0.15-oz. of R.D.X./Wax (90/10).	0.15-oz. of R.D.X./Wax (96/4).
<u>Exploder.</u>		
Main filling. ... ..	* 95.6 grs. of R.D.X./Wax.	
Filling in the flanged cup. ... ..	7.1 grs. of P.E.T.N/Wax.	
Filling in the inverted cup ... ..	* Lead azide.	
<u>Detonator.</u> ... ..	* A composition of:- Mercury fulminate, Potassium chlorate & Antimony sulphide.	

\* Quantitative analysis not carried out,  
the quantity being too small.

A P P R E C I A T I O N .

(Economic, manufacture, and development aspects).

23. There is little doubt but that this grenade is a direct copy of its German equivalent. So far as is known, however, the Germans have not adapted it as a small aircraft bomb for cluster dropping as has been done by the Japanese.

The following points deserve notice:-

- (i) The exploder unit (4) has been standardized. It is identical both in the grenade and in the bomb and is also identical with the exploder unit used in the 75-mm. hollow charge shell cased for the Type Meiji 41 Regimental gun. - See C.I.Amm. Technical Report No.30.
- (ii) The bomb which is of recent manufacture, April 1944, has a wider cone (50°) allowing a larger H.E. filling, and does not conform to the original German shape of cone, which the Japanese appear to have copied exactly in their earlier types of grenades. It is not thought that this 50° cone has anything to do with the fact that it is in the aircraft bomb, but rather that this form of cone is to be expected in all hollow charge grenades or bombs of this type, of recent manufacture, certainly after April 1944. All grenades examined with the 20° cone are of dates of manufacture in 1943 and earlier. The fact that the Japanese have turned to a wide angle cone, suggests that they are well aware of modern developments in the design of hollow charges.
- (iii) The care with which the Japanese arrange their exploder systems to ensure the maximum rate of detonation of the main filling is particularly noticeable in this instance, although it is general practice also with other types of Japanese ammunition.

24. According to Ordnance Board Proceeding No. 24706 perforations were readily obtained in firing trials at 50 yards against a 38.5-mm. homogeneous hard armour plate tilted at 30° to normal. The holes were about  $\frac{1}{8}$ " x  $\frac{5}{8}$ ". This performance was obtained using the German Gross Gewehr Panzergranate with a filling of about 5 ounces. The filling in the Japanese grenade is about  $4\frac{1}{2}$  ounces and its performance against this thickness of plate will be as good.

SUMMARY OF DATA.

	<u>H.C. Grenade.</u>	<u>H.C.A/C. Bomb.</u>
Overall length. . . . .	7-ins.	10 $\frac{1}{4}$ -ins.
Diameter over body.... .	1 $\frac{9}{16}$ -ins.	1 $\frac{9}{16}$ -ins.
Diameter over tail unit... .	1 $\frac{5}{32}$ -ins.	1 $\frac{5}{32}$ -ins.
Total weight (filled). . . .	12 $\frac{3}{4}$ -ozs.	12-ozs.
Total weight of Explosive charge... . . . .	4 $\frac{1}{2}$ -ozs.	5-ozs.
Weight and nature of H.E. filling. . . . .	3.6-ozs. of R.D.X. & Wax (50/50).	4.09-ozs. of R.D.X. & T.N.T. (49/51).
Weight and nature of Booster filling.... . . . .	0.15-ozs. of R.D.X. & Wax (90/10).	0.15-ozs. of R.D.X. & Wax (96/4).
Weight and nature of composition in detonator. . . .	... A composition of:- Mercury fulminate, Potassium chlorate & Antimony sulphide.	
Weight and nature of filling in aluminium container. . . . .	... 95.6 grs. of R.D.X. & Wax.	
Weight and nature of filling in flanged cup. . . . .	... 7.1 grs. of P.E.T.N. & Wax.	
Weight and nature of filling in inverted cup.... . . . .	... Lead azide.	
<u>Coloured band markings etc.:-</u>		
	Body and ballistic cap painted black, or rustproofed with a black finish.	
	3/8-in. yellow band $1\frac{1}{2}$ -ins. from the top of body.	3/8-in. yellow band 2-ins. from the top of body.
<u>Special features:-</u>		
	Tail extension with rifled collar.	Tail cone adapter fitted with stabili- zing vanes.



**RESTRICTED**

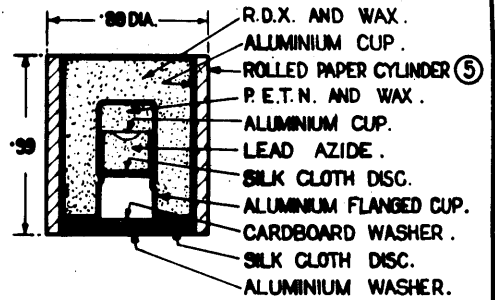
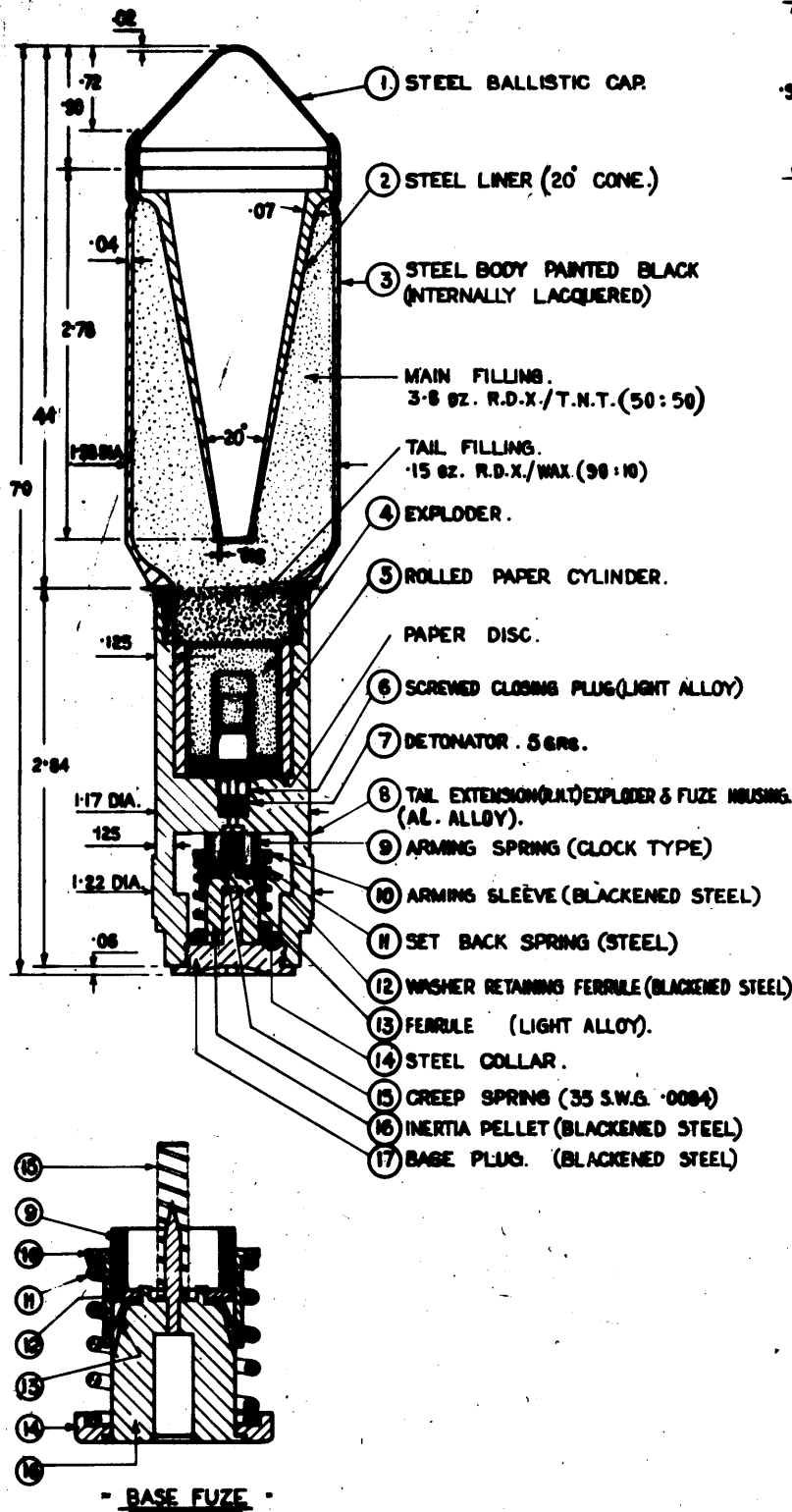

4 EXPLODER.

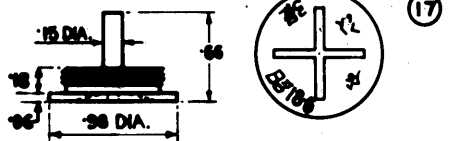
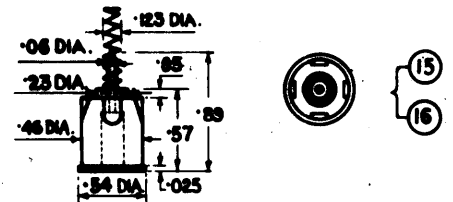
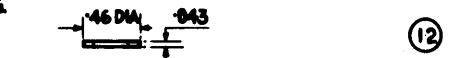
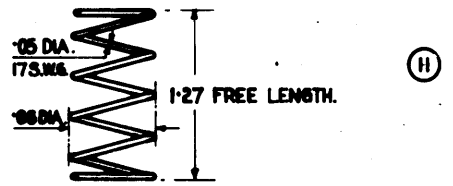
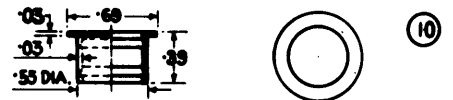
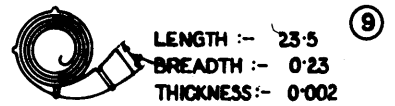

**— JAPANESE H.E. AT. GRENADE (HOLLOW CHARGE) FOR 30mm RIFLED DISCHARGER CUP —**  
**(ATTACHED TO JAPANESE RIFLES)**

**— INTERNAL DETAILS & ASSEMBLY SEQUENCE. —**

DIMENSIONS IN INCHES.

SHEET 1 OF 2 SHEETS.  
 C.I. AMM. 2/971.  
 KOFUKE, JAN. 1945.

**RESTRICTED**

COMPLETE WT. 12.75.0ZS.

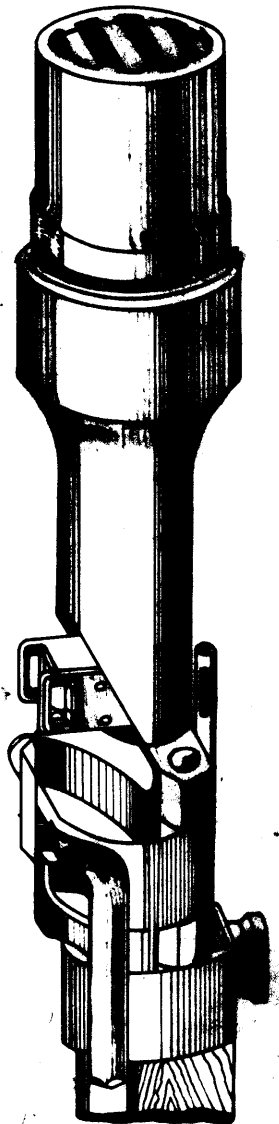
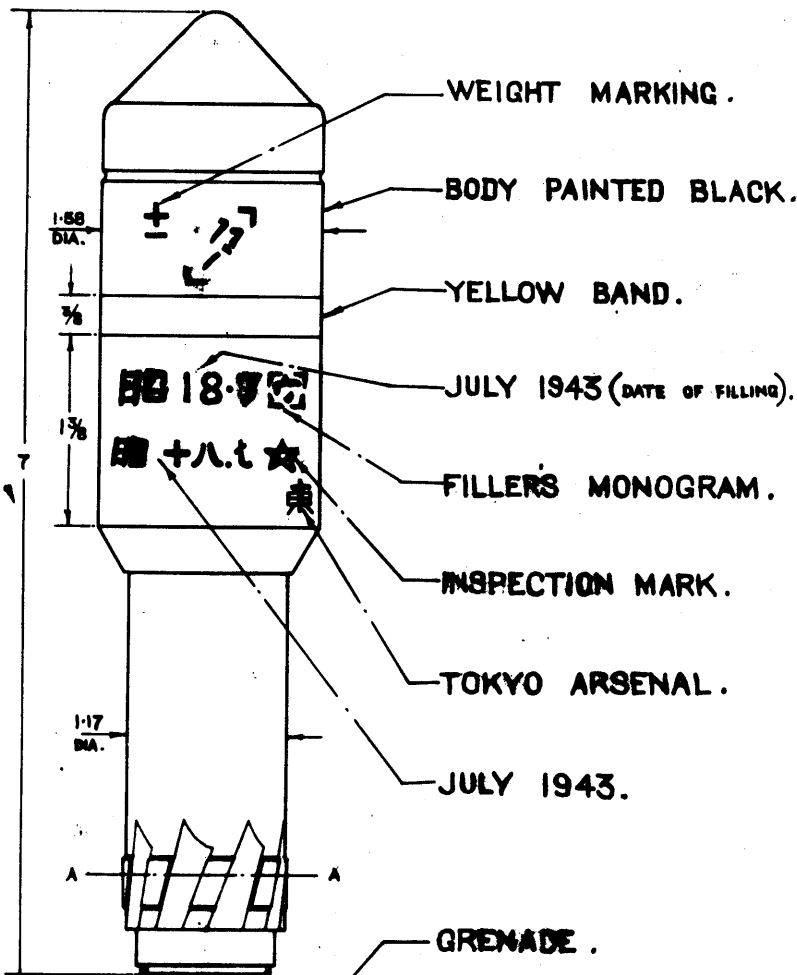

**30MM. RIFLED DISCHARGER CUP ATTACHMENT.**

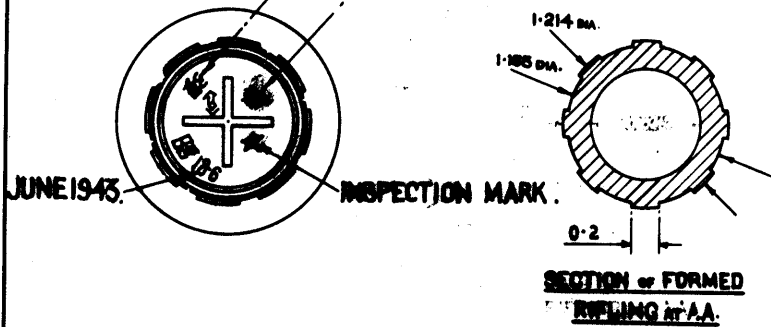

**JAPANESE H.E.A.T. GRENADE (HOLLOW CHARGE) FOR 30MM. RIFLED DISCHARGER CUP (ATTACHED TO JAPANESE RIFLES)**

**EXTERNAL APPEARANCE & MARKINGS.**

DIMENSIONS IN INCHES.

SHEET 2 OF 2 SHEETS.  
C.I.A.M.M. 9/971.  
KIRKEE, JAN. 1945.

RESTRICTED.

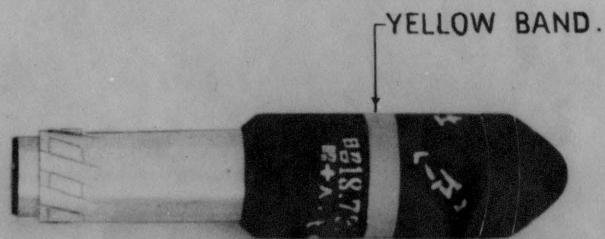
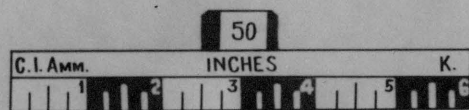

COMPLETE GRENADE.

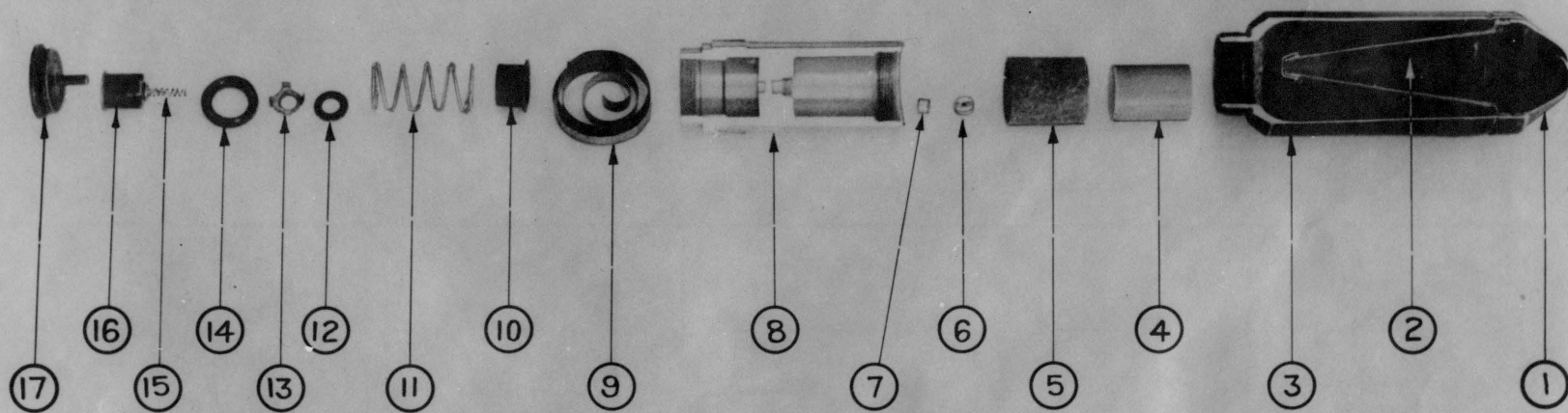

JAPANESE H.E., A.T., GRENADE (HOLLOW CHARGE).

FOR 30 MM. RIFLED DISCHARGER CUP.

EXTERNAL APPEARANCE & ASSEMBLY SEQUENCE.

C.I. AMM. S/970  
KIRKEE, JAN. 45.

**RESTRICTED.**

COMPLETE WEIGHT } :- APPROX. 12 ozs.

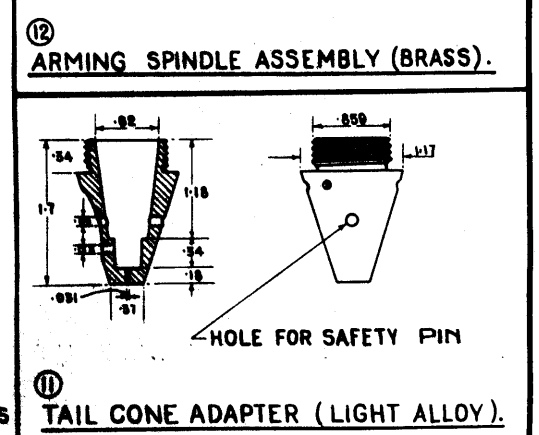
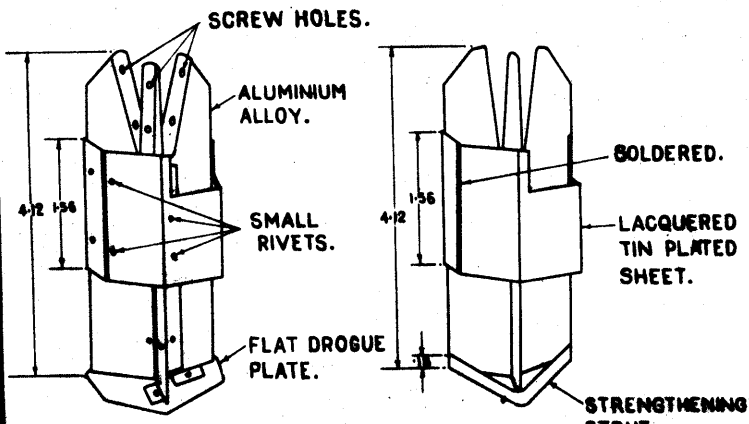
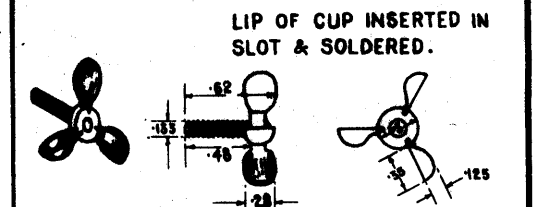
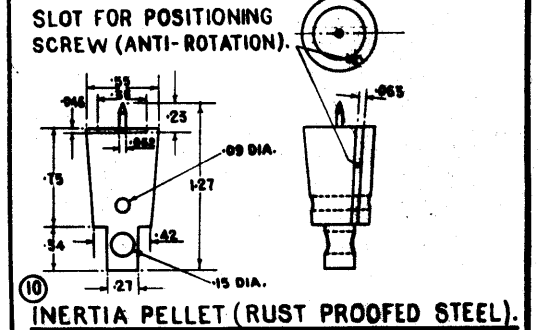
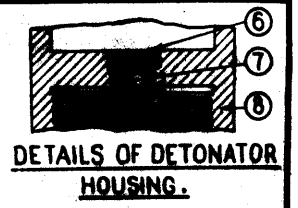
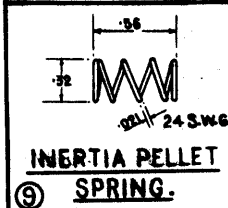
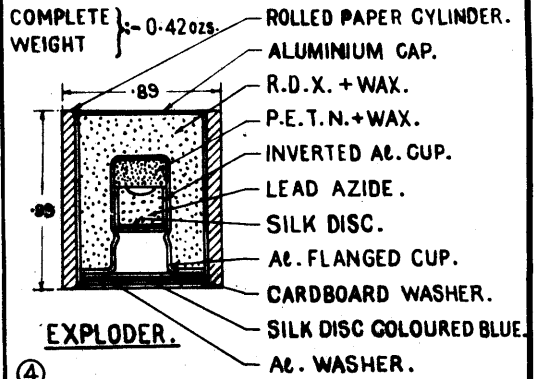
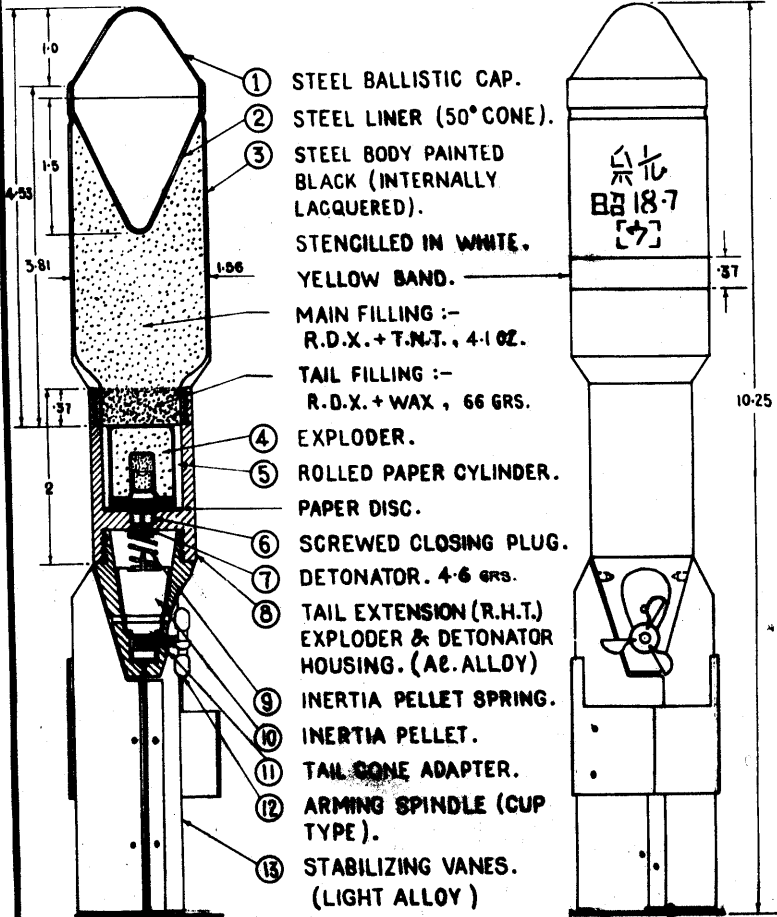

**JAPANESE 1/3 Kg. H.E. AIRCRAFT BOMB. (HOLLOW CHARGE)**

**INTERNAL DETAILS & DIMENSIONS.**

DIMENSIONS ARE IN INCHES.

C.I. AMM. S/969  
 KIRKEE JAN 45

RESTRICTED.

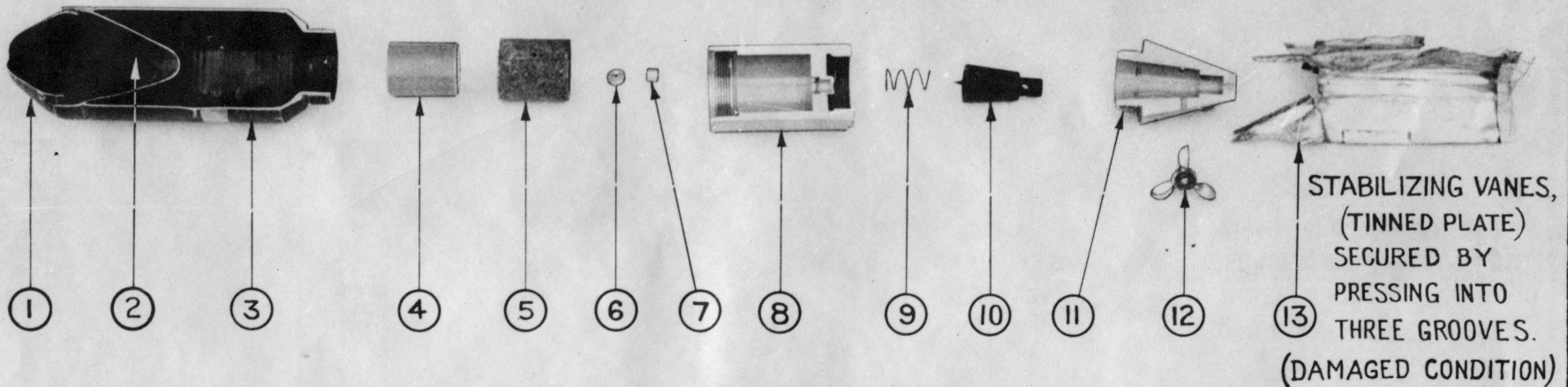
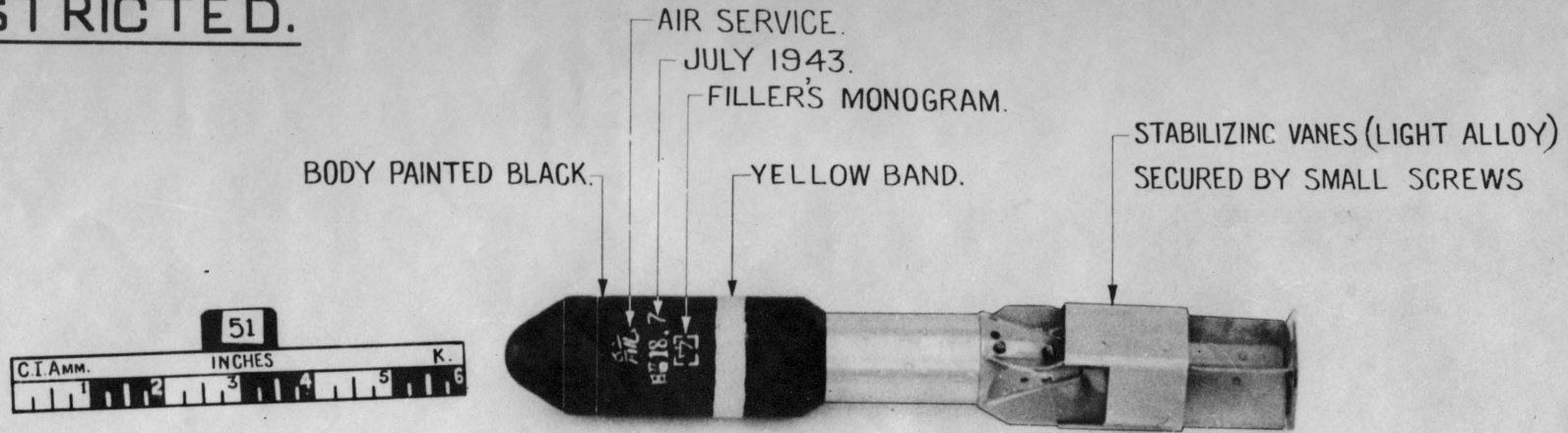

JAPANESE 1/3 Kg. H.E. AIRCRAFT BOMB (HOLLOW CHARGE).  
EXTERNAL APPEARANCE & ASSEMBLY SEQUENCE.

C.I. AMM.S/968  
KIRKEE. JAN. 45.

PLATE E.  
PLATE E.

RESTRICTED.

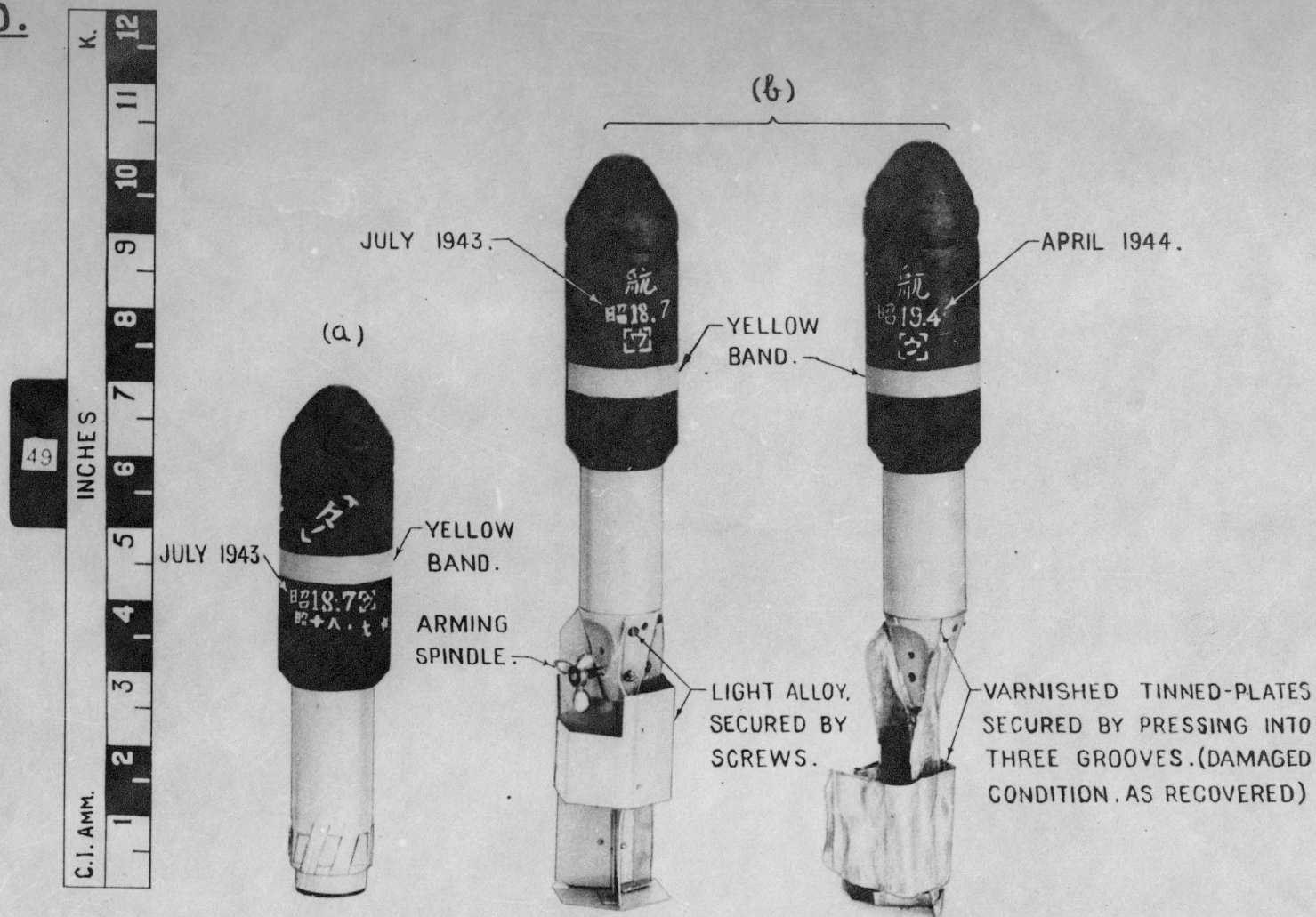

JAPANESE

(a) GRENAD E.H.E., A.T., HOLLOW CHARGE (30 MM.)

(b) 1/3 Kg. H.E., AIRCRAFT BOMB (HOLLOW CHARGE)

COMPARATIVE PHOTOGRAPH

C.I.Amm S/984  
KIRKEE JAN 45